



Check Valves

V33, VP33, VA33, VDA33, VH36 and VL36 Series

for VCH36 Series for CNG/NGV applications

Pressures up to 3,000 psig (206 bar) and 6,000 psig (413 bar)

Features

- Fixed cracking pressure valves : V33, VP33, VH36, VCH36 Series
- Adjustable cracking pressure valves : VA33, VDA33 Series
- Lift Check valves : VL36 Series

Technical Information

Valve Series	V33 Series			VP33 Series	VA33 & VDA33 Series	VH36 Series	
	V33A, V33B, V33C, V33D	V33E, V33F		VP33A, VP33B	VA33A, VA33B, VDA33	VH36A, VH36B	VH36C
Materials	SS316 & Brass	SS316	Brass	SS316 & Brass	SS316 & Brass	SS316	SS316
Maximum Working Pressure @ 70°F (21°C) Unit : psig (bar)	3000 (206)	2000 (137)	1500 (103)	3000 (206)	3000 (206)	6000 (413)*	5000 (344)*
Temperature Ratings °F (°C)	Seal Material	Designator		Rating	Seal Material	Designator	Rating
	FKM O-ring	VT		-10 to 375 (-23 to 190) ^(a)	EPDM O-ring	EP	-50 to 300 (-45 to 148)
	NBR O-ring	BN		-10 to 250 (-23 to 121)	FFKM O-ring	KZ	-10 to 600 (-23 to 315)
(a)VH36 Series with FKM O-ring : -10 to 400 °F (-23 to 204 °C) • FKM is standard for SS316 valves. • NBR is standard for Brass valves.							
Cracking Pressure	Refer to spring table of each valve series						

- Poppet Check Valves, V33 Series : 2, 3 page
- One-Piece Check Valves, VP33 Series : 3 page
- One-Piece Adjustable Check Valves, VA33 Series : 4, 5 page
- In-Line Adjustable Check Valves, VDA33 Series : 4, 5 page
- CNG/NGV Check Valves, VCH36 Series : 6, 7 page
- High Pressure Check Valves, VH36 Series * : 6, 7 page
- Lift Check Valves, VL36 Series : 8 page

Cracking, Reseal and Back Pressure @ 70°F(21°C)

- Cracking Pressure : Valve poppet is actuated when the pressure difference between the inlet (upstream) and the outlet (downstream) reaches the range of cracking pressure.
- Reseal Pressure : Valves that have higher cracking pressure can be resealed to bubble-tight by the spring force. The reseal pressure is the pressure at the same flow direction, but lower than the cracking pressure.
- Back Pressure : Valves that have cracking pressure of 5 psig (0.34 bar) and lower may not be able to return to the bubble-tight seal. This may require back pressure to press the seal to form a bubble-tight contact in addition to the spring force.

Class Ratings

Valve Series	V33 Series				VP33, VA33, VDA33 Series		VH36 Series	
	V33A, V33B, V33C, V33D	V33E, V33F		VP33A, VP33B, VA33A, VA33B, VDA33		VH36A, VH36B	VH36C	
Temperature, °F (°C)	Working Pressure, psig (bar)							
	SS316	Brass	SS316	Brass	SS316	Brass	SS316	SS316
-18 to 100 (-28 to 38)	3000 (206)	3000 (206)	2000 (137)	1500 (103)	3000 (206)	3000 (206)	6000 (413)	5000 (344)
200 (93)	2575 (177)	2600 (179)	1715 (118)	1300 (89)	2575 (177)	2600 (179)	5160 (355)	4290 (295)
225 (175)	2510 (172)	2500 (172)	1670 (115)	1250 (86)	2510 (172)	2500 (172)	5030 (346)	4180 (288)
250 (121)	2450 (168)	2405 (165)	1630 (112)	1200 (82)	2450 (168)	2405 (165)	4910 (338)	4080 (281)
300 (148)	2325 (160)	-	1545 (106)	-	2325 (160)	-	4660 (321)	3875 (267)
350 (176)	2255 (155)	-	1490 (102)	-	2255 (155)	-	4470 (308)	3720 (256)
375 (190)	2185 (150)	-	1450 (99)	-	2185 (150)	-	4375 (301)	3640 (250)
400 (204)	-	-	-	-	-	-	4280 (294)	3560 (245)

* VH36 & VCH36 Series is Pressure ratings may be limited by the end connection. See Page 7, Dimensions Table.



IDK-LOK® Check Valves

V33 series

Features

- Working pressure up to 3,000 psig (206 bar)

V33A/B/C/D Series

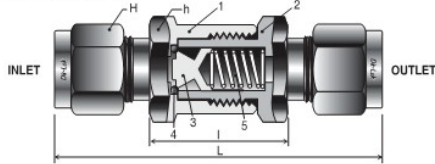

V33E/F Series

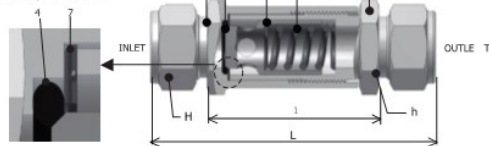

Material of Construction

Component	Valve Body Materials	
	Stainless Steel	Brass
	Material Grade/ASTM	
1. Body	SS316 /A276, A479	Brass 360 /B16
2. Connector		
3. Poppet		
4. O-ring*	FKM	NBR
5. Spring	SS302/A313	
6. O-ring seal	FKM	NBR
7. Washer	SS316 With PTFE Coating	

Wetted parts are listed in blue.

- 4. O-ring* on V33E & V33F Series is secured in poppet groove.

Lubrication :

- Silicon-based Lubricant for Poppet.
- Molybdenum Dry Film Lubricant for SS316 Body Threads.

Operation

- Valves that have not been actuated for a period of time may require a higher cracking pressure than the set cracking pressure.
- DK-Lok check valves prevent reverse flow in circuits. Do not use them as relief valves.
- DK-Lok check valves are designed to prevent loss of media caused by failed connections and for uni-directional flow control of fluids in chemical processing, power generation, oil and gas industries.

Factory Test, Cleaning and Packaging

- Every valve is factory tested for cracking and reseals performance.
- Every valve is cleaned, and packaged in accordance with DK-Lok cleaning standard of DC-01.
- Special cleaning and packaging in accordance with DK-Lok DC-11 in compliance with ASTM G93 Level C is available on request.

Ordering Information and Dimensions

Basic Ordering Number	End Connections		Orifice mm (in.)	Cv	Dimensions mm (in.)				
	Inlet	Outlet			h-Hex	H-Hex	L	I	
V33A-	D-2T-	1/8 in. DK-Lok	4.8 (0.19)	0.16	15.88 (5/8)	11.11 (7/16)	55.60 (2.19)	25.00 (0.98)	
	M-2N-	1/8 in. Male NPT				-	44.40 (1.75)	-	
	F-2N-	1/8 in. Female NPT				-	46.50 (1.83)	-	
	D-4T-	1/4 in. DK-Lok		0.47		14.29 (9/16)	60.00 (2.36)	25.00 (0.98)	
	D-6M-	6 mm DK-Lok				14.00	-		
	MD-4N4T-	1/4 in. Male NPT 1/4 in. DK-Lok				14.29 (9/16)	56.40 (2.22)		
M-4N-	1/4 in. Male NPT	-	53.40 (2.10)	-					
V33B-	F-4N-	1/4 in. Female NPT	7.1 (0.28)	1.48	19.05 (3/4)	-	56.80 (2.24)	-	
	D-6T-	3/8 in. DK-Lok				17.46 (11/16)	65.50 (2.58)	27.10 (1.07)	
	D-10M-	10 mm DK-Lok				19.00	-		
	M-6N-	3/8 in. Male NPT				-	55.50 (2.19)	-	
V33C-	F-6N-	3/8 in. Female NPT	10.0 (0.39)	1.7	22.22 (7/8)	-	63.80 (2.51)	-	
	D-8T-	1/2 in. DK-Lok				22.22 (7/8)	80.20 (3.16)	36.20 (1.43)	
	D-12M-	12 mm DK-Lok				22.00	-		
	M-8N-	1/2 in. Male NPT				-	74.40 (2.93)	-	
V33D-	F-8N-	1/2 in. Female NPT	13.5 (0.53)	2.6	28.58 (1-1/8)	-	84.70 (3.33)	-	
	D-10T-	5/8 in. DK-Lok				25.40 (1)	91.80 (3.61)	48.10 (1.89)	
V33E-	D-12T-	3/4 in. DK-Lok	16.0 (0.63)	5.2	31.75 (1-1/4)	28.58(1-1/8)	110.70 (4.35)	66.1 (2.6)	
	M-12N-	3/4 in. Male NPT				-	105.30 (4.15)		-
	F-12N-	3/4 in. Female NPT				-	103.00 (4.06)	-	
V33F-	D-16T-	1 in. DK-Lok	18.0 (0.71)	8.0	34.93 (1-3/8)	38.1 (1-1/2)	120.8 (4.75)	68 (2.68)	
	M-16N-	1 in. Male NPT				-	115.8 (4.56)		-
	F-16N-	1 in. Female NPT				-	111 (4.37)		-



IDK-LOK® Check Valves

Table 1. Spring Cracking, Reseal and Back Pressure @ 70 °F (21 °C) (for V33)

Spring Nominal Cracking Pressure Designator		Cracking Pressure Ranges				Reseal Pressures psig (bar)
psig	bar	Min. Pressure		Max. Pressure		
		psig	bar	psig	bar	
1/3	0.02	0	0	3	0.21	Up to 6 (0.41) Back pressure
1	0.07	0	0	4	0.28	Up to 6 (0.41) Back pressure
3	0.21	2	0.14	7	0.48	Up to 4 (0.28) Back pressure
10	0.69	7	0.48	15	1.03	Minimum 3 (0.21) Reseal pressure
25	1.72	20	1.38	30	2.07	Minimum 17 (1.17) Reseal pressure
50	3.45	40	2.76	60	4.14	Minimum 35 (2.41) Reseal pressure
75	5.17	60	4.14	90	6.20	Minimum 53 (3.65) Reseal pressure
100	6.89	80	5.51	120	8.27	Minimum 70 (4.82) Reseal pressure

VP33 Series One-Piece Check Valves

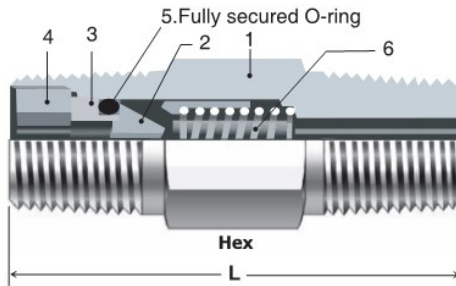

Features

- O-ring seal blow-out proof design
- One piece body construction.
- Working pressure up to 3,000 psig (206 bar)

Materials of Construction

Component	Valve Body Materials	
	Stainless Steel	Brass
Material Grade/ASTM		
1. Body	SS316 / A276, A479	Brass 360 / B16
2. Poppet		
3. O-ring Holder		
4. Locking Screw		
5. O-ring	FKM	NBR
6. Spring	SS302/A313	

Wetted parts are listed in blue.

Lubrication :

- Silicon-based Lubricant on Poppet
- Molybdenum Dry Film Lubricant on SS316 Locking Screw.

Ordering Information and Dimensions

Basic Ordering Number	End Connections		Cv	Dimensions mm (in.)	
	Inlet	Outlet		L	Hex.
VP33A-	M-4N-	1/4 in. Male NPT	0.35	41 (1.62)	14.28 (9/16)
	M-4R-	1/4 in. ISO Male Tapered		61 (2.41)	19.05 (3/4)
	F-4N-	1/4 in. Female NPT			
	F-4R-	1/4 in. ISO Female Tapered			
	MF-4N-	1/4 in. Male NPT			
	FM-4N-	1/4 in. Female NPT		1/4 in. Male NPT	58 (2.28)
VP33B-	M-8N-	1/2 in. Male NPT	1.20	58 (2.28)	22.22 (7/8)
	F-8N-	1/2 in. Female NPT		94 (3.71)	26.98 (1-1/16)
	MF-8N-	1/2 in. Male NPT		1/2 in. Female NPT	

Table 2. Spring Cracking, Reseal and Back Pressure @ 70°F (21°C)

Spring Nominal Cracking Pressure Designator		Cracking Pressure Ranges				Reseal Pressures psig (bar)
psig	bar	Min. Pressure		Max. Pressure		
		psig	bar	psig	bar	
1/3	0.02	0	0	3	0.21	6 to 20 (0.41 to 1.38) back pressure
1	0.07	0	0	4	0.28	5 to 20 (0.34 to 1.38) back pressure
10	0.69	7	0.48	13	0.90	3 to 10 (0.21 to 0.69) back pressure
25	1.72	21	1.45	29	2.00	Minimum 5 (0.34) Reseal pressure



IDK-LOK® Check Valves

VA33 Series One-Piece Adjustable Check Valves / VDA33 Series In-Line Adjustable Check Valves

Features

- Cracking pressure adjustable from 3 to 600 psig (0.2 to 41.3 bar)
- Working pressure up to 3,000 psig (206 bar)
- Temperature up to 190°C (375°F) with FKM O-ring
- Standard materials : 316 stainless steel and brass.

VA33 Series

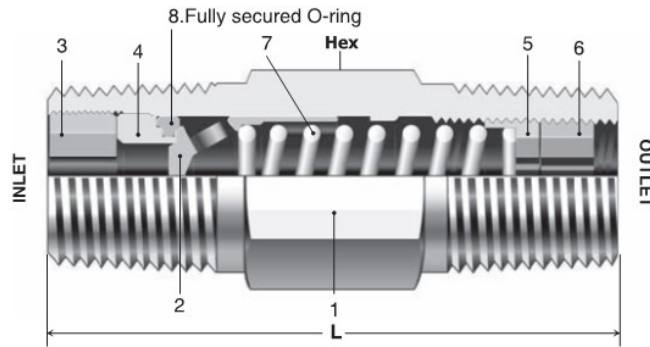

VDA33 Series

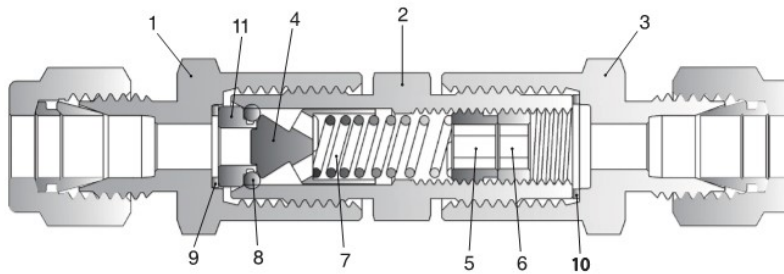

Materials of Construction

Component		Valve Body Materials	
		Stainless Steel	Brass
		Material Grade/ASTM	
VA33 Series	VDA33 Series	SS316 /A276, A479	Brass 360 / B16
1. Body	1. Inlet body 2. Center body 3. Outlet body		
2. Poppet 360 / B16	4. Poppet		
3. Insert locking screw	-		
4. Insert	11. Insert		
5. Adjustable screw	5. Adjustable screw		
6. Locking screw	6. Locking screw	SS302/A313	
7. Spring	7. Spring	FKM, Optional FFKM	NBR
8. O-ring	8. O-ring	TFE coated SS316	
	9. Inlet gasket 10. Outlet gasket		

Wetted parts are listed in blue.

Lubrication :

- Silicon-based Lubricant on Poppet
- Molybdenum Dry Film Lubricant on SS316 Locking Screw and Insert Locking Screw.



IDK-LOK® Check Valves

VA33 Series Ordering Information and Dimensions

Basic Ordering Number	End Connections	Cv	L		Hex
			mm	in.	
VA33A-	F-4N 1/4 in. Female NPT	0.35	75.7	2.98	3/4
	M-4N- 1/4 in. Male NPT		41.1	1.62	9/16
	M-4R- 1/4 in. ISO Male Tapped		41.1	1.62	9/16
VA33B-	M-8N- 1/2 in. Male NPT	1.2	65.0	2.56	7/8
	M-8R- 1/2 in. ISO Male Tapped		65.0	2.56	7/8



VDA33 Series Ordering Information and Dimensions

Basic Ordering Number	End Connections		Cv	Dimensions mm(in.)		
	Inlet	Outlet		L	H	h
VDA33	D-4T-S 1/4 in. DK-Lok	1/4 in. DK-Lok	0.37	82.0(3.23)	9/16 in.	5/8 in.
	D-6M-S 6mm DK-Lok			82.0(3.23)	14mm	
	D-8M-S 8mm DK-Lok			84.3(3.32)	16mm	
	MD-4N4T-S 1/4 in. Male NPT			79.2(3.12)	9/16 in.	

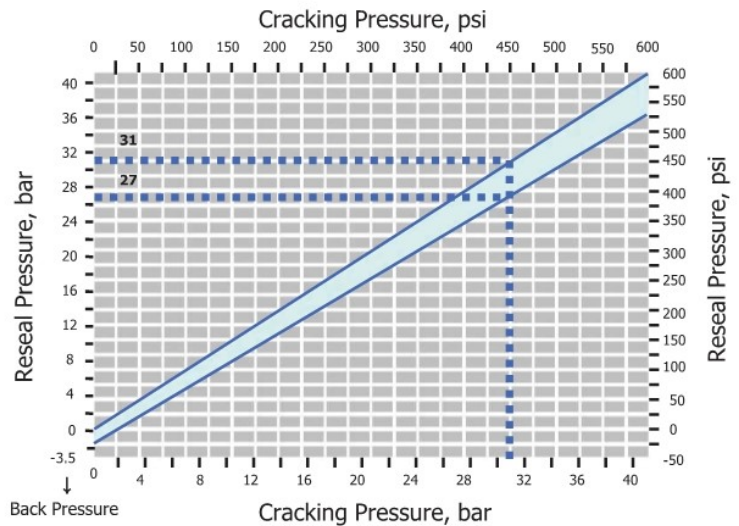

Table 3. Spring Cracking Pressure Range Designator

Cracking Pressure Range @21 °C (70 °F)		Designator
psig	bar	
3 to 50	0.2 to 3.4	3
50 to 150	3.4 to 10.3	50
150 to 350	10.3 to 24.1	150
350 to 600	24.1 to 41.3	350

Cracking Pressure vs. Reseal pressure

VA33 and VDA33 Series valves set to crack at 20 psig(1.3 bar) or lower may require back pressure(downstream pressure) to reseal the valve bubble tight.



Example shown : For a valve set to crack at 31 bar (450 psig), the minimum reseal pressure would be 27 bar (390psig).

How to adjust cracking pressure

Step 1	Step 2	Step 3
<p>Slightly unscrew the locking screw counter-clockwise.</p>	<p>1. Gently slide the allen key up to adjustable screw position. 2. Adjust cracking pressure. • To increase cracking pressure, turn adjustable screw clockwise. • To decrease cracking pressure, turn adjustable screw counter-clockwise.</p>	<p>1. Move out the allen key up to the locking screw position. 2. To lock out the locking screw, turn the allen key clockwise.</p>



IDK-LOK® Check Valves

VH36 Series High Pressure Check Valves / VCH36 Series CNG/NGV Check Valves

Features

- High pressure 6,000 psig (413 bar)
- Seal blow-out proof design with the bonded seal on poppet.

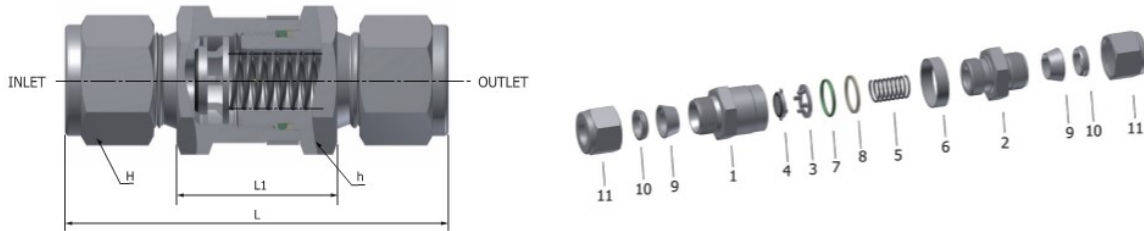

Materials of Construction

Component	Valve Body Material
	Stainless Steel
	Material Grade/ASTM
1. Body	SS316 /A479, A276
2. Connector	
3. Poppet stop	
4. Poppet with bonded seal	Poppet: SS316 /A479, A276 Bonded Seal : FKM, optional EPDM & Kalrez HNBR standard for VCH36 Series
5. Spring	SS302 /A313
6. Indicator ring*	SS316 /A276
7. O-ring	FKM / HNBR standard for VCH36 Series
8. Backup ring	PTFE /D1710
9, 10, 11. DK-Lok Front & Back Ferrule and Nut	SS316 /A479, A276

Wetted parts are listed in blue.

* Indicator ring bears the information of spring designator.

Lubrication :

- Silicon-based Lubricant on Poppet
- Molybdenum Dry Film Lubricant on SS316 Connector threads

CNG Certifications

VCH36 Series check valve with CNG compatible HNBR O-ring are available with CNG certifications.

Certificates	ECE R110	ANSI / AGA NGV 3.1-1995 CGV NGV 12.3-M95	ISO 15500
Certificate No.	110R-000186	2010-REPORT-014 (00)	2010-REPORT-013 (00)
Classification	Class 0	Check valve	Check valve
Temperature	-40 to 120 °C (-40 to 250 °F)	-40 to 121 °C (-40 to 250 °F)	-40 to 121 °C (-40 to 250 °F)
Working Pressure	274 bar @ 120 °C	273 bar @ 121 °C	273 bar @ 121 °C

Table 4. Spring Cracking, Reseal and Back Pressure @ 70 °F (21 °C)

Spring Nominal Cracking Pressure Designator		Cracking Pressure Ranges				Reseal Pressures psig (bar)
		Min. Pressure		Max. Pressure		
psig	bar	psig	bar	psig	bar	
1/3	0.02	0	0	3	0.21	Up to 6 (0.41) back pressure
1	0.07	0	0	4	0.28	Up to 5 (0.35) back pressure
5	0.34	3	0.21	9	0.62	Up to 2 (0.14) back pressure
10	0.69	7	0.48	15	1.03	Minimum 3 (0.21) Reseal pressure
25	1.72	20	1.38	30	2.07	Minimum 17 (1.2) Reseal pressure

Sour Gas Service

Materials of VH36 series valves for sour gas service are selected in accordance with the requirements of NACE MR0175

- Spring : alloy X-750/AMS5699
- Nominal Cracking Pressure : 1/3, 1, and 5 psig (0.03, 0.07 and 0.035 bar)
- Seal : ethylene propylene.

To order, insert-SG in the ordering number. i.e., VH36B-D-8T-SG-S



IDK-LOK® Check Valves

Ordering Information and Dimensions

Basic Ordering Number	End Connections	Cv	Dimensions mm (in.)				Pressure Rating psig (bar)	
			L	L1	H	h		
VH36A- VCH36A-	D-2T-	1/8 in. DK-Lok	0.67	57.7 (2.27)	26.4 (1.04)	11.11 (7/16)	11/16	6000 (413)
	D-4T-	1/4 in. DK-Lok		61.7 (2.43)	26.4 (1.04)	14.29 (9/16)		
	D-6M-	6 mm DK-Lok		61.7 (2.43)	26.4 (1.04)	14		
	F-4N-	1/4 in. Female NPT		54.1 (2.13)	-	-		
	M-2N-	1/8 in. Male NPT		45.5 (1.79)	26.4 (1.04)	-		
	M-4N-	1/4 in. Male NPT		55.1 (2.17)	26.4 (1.04)	-		
VH36B- VCH36B-	D-6T-	3/8 in. DK-Lok	1.8	69.9 (2.75)	31.2 (1.23)	17.46 (11/16)	1	6000 (413)
	D-8T-	1/2 in. DK-Lok		75.2 (2.96)	31.2 (1.23)	22.22 (7/8)	1	
	D-8M-	8 mm DK-Lok		68.6 (2.70)	31.2 (1.23)	16	1	
	D-10M-	10 mm DK-Lok		71.1 (2.80)	31.2 (1.23)	19	1	
	D-12M-	12 mm DK-Lok		75.2 (2.96)	31.2 (1.23)	22	1	5300 (365)
	F-6N-	3/8 in. Female NPT		64.8 (2.55)	-	-	1	
	F-8N-	1/2 in. Female NPT		77.0 (3.03)	-	-	1-1/16	4900 (337)
	M-6N-	3/8 in. Male NPT		59.9 (2.36)	31.2 (1.23)	-	1	6000 (413)
	M-8N-	1/2 in. Male NPT		69.3 (2.73)	31.2 (1.23)	-	1	
	VH36C- VCH36C-	D-12T-		3/4 in. DK-Lok	4.7	89.4 (3.52)	45.2 (1.78)	28.58 (1-1/8)
D-16T-		1 in. DK-Lok	98.6 (3.88)	45.5 (1.79)		38.1 (1-1/2)	4700 (323)	
D-22M-		22 mm DK-Lok	88.4 (3.48)	45.5 (1.79)		32	4900 (337)	
D-25M-		25 mm DK-Lok	98.6 (3.88)	45.5 (1.79)		40	4600 (316)	
F-12N-		3/4 in. Female NPT	82.0 (3.23)	82.0 (3.23)		-	4600 (316)	
F-16N-		1 in. Female NPT	97.3 (3.83)	97.3 (3.83)		-	4400 (303)	
M-12N-		3/4 in. Male NPT	83.6 (3.29)	45.5 (1.79)		-	5000 (344)	
M-16N-		1 in. Male NPT	93.2 (3.67)	45.7 (1.80)		-		

How to Order

Select valve basic ordering number, applicable seal, spring nominal cracking pressure, and body material.

V33A-D-4T-
VP33B-F-8N-
VH36C-D-16T-

BN-

VT-

EP-

1/3-

1-

3-

S

B

S

Seal Material Designator	Spring Nominal Cracking Pressure Designator	Valve Body Material Designator
FKM : Nil for SS316 Valve NBR : Nil for Brass Valve HNBR : Nil for VCH36 CNG valves FKM : VT NBR : BN EPDM : EP FFKM : KZ	1/3 : 1/3 psig 1 : 1 psig 3 : 3 psig 10 : 10 psig 25 : 25 psig Note : Select the spring designator from Table 1, 2, 3 and 4 of each valve Series.	S : 316 stainless steel B : Brass (exceptional VH36 Series)

Spare Kits for Field Assembly

Spring

Prefix "9SPR" and select an applicable valve series and the designator of the spring nominal cracking pressure.
9SPR-(Valve series)-(spring designator)-2
Example : 9SPR-V33A-1/3-2

How to order VH36 Series spring kit.

VH36 spring kit contains a spring and an indicator ring.
Select an applicable valve series and the designator of the spring nominal cracking pressure.
(Valve series)-RINGSPR-(spring designator)-SA
Example : VH36A-RINGSPR-5-SA

O-ring

Prefix "9ORG", select an applicable valve series and seal material designator.
Example : 9ORG-V33A-BN

How to order VH36 Series seal kit.

VH36 seal kit contains (Refer to VH36 Materials of Construction) #4. Poppet with bonded seal, #7. O-ring and #8. Backup ring.
Select an applicable valve series and seal material designator
SK-(valve series)-(seal material designator)
Examples : SK-VH36A-VT, SK-VH36B-BN.



IDK-LOK® Check Valves

VL36 Series Lift Check Valves

Features

- Working pressure up to 6,000 psig (413 bar)
- Temperature up to 900 °F (482 °C)
- Metal to metal seat

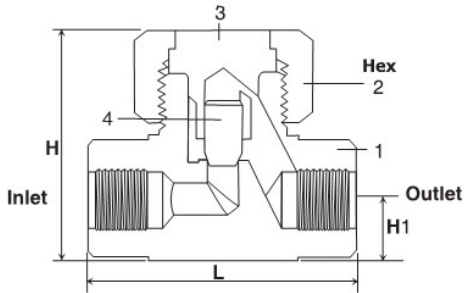

Operation

- Operation of this valve heavily depends on gravity assistance. Thus mounting horizontally with bonnet nut upward to allow poppet to operate vertically.
- Reverse flow closes the valve, keeping poppet in the orifice.
- Forward flow opens the valve, lifting the poppet
- Lift check valve is primarily for use in liquid systems. If a slight amount of leakage can be tolerated it can be used with heavy gases.
- Reverse flow Cv is limited to less than 0.1% of forward Cv.

Materials of Construction

Component	Valve Body Material
	Material Grade/ASTM
1. Body	SS316/A276 or A479

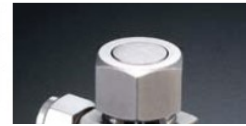

Complete Ordering Number and Dimensions

Complete Ordering Number	End Connection	Orifice		Cv	Dimensions mm (in.)			
		mm	inch		L	H	H1	Hex
VL36A-	D4T-S	4.0	0.156	0.30	61.0 (2.40)	37.3 (1.47)	9.9 (.39)	7/8
	D6M-S							
	F2N-S							
	F4N-S							
	SW4T-S							
VL36B-	D6T-S	6.4	0.250	0.64	71.9(2.83)	47.0 (1.85)	12.7 (.50)	1 1/4
	F4N-S							
	SW6T-S							
	SW8T-S							
VL36C-	D8T-S	11.1	0.437	2.20	99.6 (3.92)	62.0 (2.44)	15.7 (.62)	1 1/2
	D12T-S							
	F6N-S							
	F8N-S							
	SW8T-S							

Pressure-Temperature Ratings

ASME Class	2500	
Material Group	2.2	
Material Name	SS316	
Temp. °F (°C)	Working Pressure psig (bar)	
	-65 to 100 (-53 to 37)	6000 (413)
	200 (93)	5160 (355)
	300 (148)	4660 (321)
	400 (204)	4280 (294)
	500 (260)	3980 (274)
	600 (315)	3760 (259)
	700 (371)	3600 (248)
800 (426)	3460 (238)	
900 (482)	3280 (225)	

How to order : Select a complete ordering number. i.e., VL36A-D-4T-S.

All dimensions shown are for reference only and subject to change. Dimensions with DK-LOK are in finger-tight position. We reserve the right to change specification stated in this catalog for our continuing program of product improvement.

Safe Valve Selection

The selection of a valve for any application or system design must be considered to ensure safe performance. Valve function, valve rating, material compatibility, proper installation, operation and maintenance remain the sole responsibility of the system designer and the user. DK-Lok accepts no liability for any improper selection, installation, operation or maintenance.

