

ASCO™ Solenoid Valves

single/dual solenoid (mono/bistable function) - pilot operated
 stainless steel body - 1/4" and 1/2" tapped

Features

- The monostable spool valves in conformity with IEC 61508 Standard (2010 route 2_H version) have TÜV (551 series) and EXIDA (551-553 series) certified with integrity levels: SIL 2 for HFT = 0 / SIL 3 for HFT = 1
- The 5/2 and 5/3 solenoid operated spool valves have threaded port connections
- All the exhaust ports of the spool valve are connectable, providing better environmental protection. Particularly recommended for sensitive areas, such as clean rooms, and applications in the pharmaceutical and food processing sectors
- The valves offer environmental protection against the ingress of liquids, dusts or other foreign matter (environmentally-protected construction)
- Can be externally piloted (external air pilot supply) to convert valve to zero minimum operation by flipping a gasket
- The solenoid valves satisfy all relevant EU directives



General

Differential pressure 2 - 10,4 bar [1 bar = 100 kPa]
Flow (Qv at 6 bar) 1/4 = 860 l/min (5/2) ; 760 l/min (5/3) (ANR)
 1/2 = 3000 l/min

fluids (*)	temperature range (TS)	seal materials (*)
air, inert gas, filtered	551: -40°C to +80°C	VMQ (silicone) + PUR (polyurethane)
	553: -40°C to +60°C	

Materials in contact with fluid

(*) Ensure that the compatibility of the fluids in contact with the materials is verified

Body, end covers	Stainless steel, AISI 316L
Spool valve internal parts	Stainless steel, POM
Core tube	Stainless steel
Core and plugnut	Stainless steel
Core spring	Stainless steel
Seals & discs	NBR
Top disc	FPM
Disc holder	POM
Cartridge (Low power)	Welded, packless AISI 430
Seat	Stainless steel
Seat insert	POM
Shading coil	Silver
Rider ring (Low power)	PTFE (NF/WSNF solenoids only)

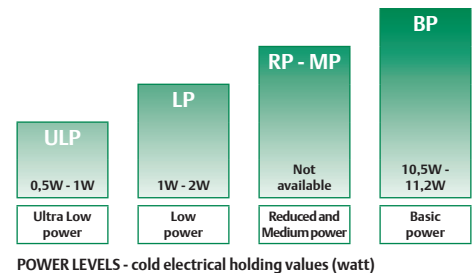
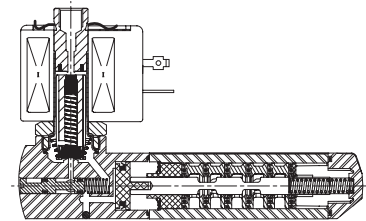

POWER LEVELS - cold electrical holding values (watt)

Specifications

pipe size	orifice size	flow coefficient Kv		operating pressure differential (bar)			power level	prefix optional solenoids								basic catalogue number						
								min. ⁽¹⁾	max. (PS)		NEMA 7 & 9	NEMA 7 & 9 ATEX IECEx	ATEX / IECEx				IP65					
									air (*)				Ex db	Ex eb mb	Ex mb			Ex ia				
(*)	(mm)	(m³/h)	(l/min)	~	=	~/=	EF ⁽²⁾	EV ⁽²⁾	LPKF	NF	EM	PV	LI	WSLI	SC							
5/2 - Solenoid air pilot operated - spring return (monostable)																						
1/4	6	0,75	12,5	0/2	10	10	BP	-	-	-	●	●	●	-	-	●	❖551A421 ⁽³⁾					
							BP	●	●	-	-	-	-	-	-	-	-	●	❖551H421 ⁽³⁾			
							LP	-	-	●	●	●	○	-	-	-	-	●	❖551A321 ⁽³⁾			
							LP	○	○	-	-	-	-	-	-	-	-	-	-	●	❖551G321 ⁽³⁾	
							ULP	-	-	○	-	-	-	○	○	-	-	-	-	-	●	❖551A321 ⁽³⁾
							ULP	○	○	-	-	-	-	-	-	-	-	-	-	-	-	●
1/2	13	3,15	52,5	0/2	10	10	BP	-	-	-	●	●	●	-	-	●	❖553A421 ⁽³⁾					
							BP	●	●	-	-	-	-	-	-	-	-	-	●	❖553H421 ⁽³⁾		
							LP	-	-	●	●	●	○	○	○	○	○	●	❖553A321 ⁽³⁾			
							LP	○	○	-	-	-	-	-	-	-	-	-	-	●	❖553G321 ⁽³⁾	
							ULP	-	-	○	-	-	-	○	○	-	-	-	-	-	●	❖553A321 ⁽³⁾
							ULP	○	○	-	-	-	-	-	-	-	-	-	-	-	-	●

❖ Select 8 for NPT ANSI 1.20.3 or select G for ISO G (228/1) ● Available feature ○ Available feature in DC only. - Not available

⁽¹⁾ Zero minimum is only achieved if external pressure is applied.

⁽²⁾ UL CSA

⁽³⁾ Certified IEC 61508 Functional Safety data, use suffix "SL".

**5/2 - 5/3
SERIES
551 - 553**

Specifications

pipe size	orifice size	flow coefficient Kv		operating pressure differential (bar)			power level	prefix optional solenoids										basic catalogue number	
								min. ⁽¹⁾	max. (PS)		NEMA 7 & 9	NEMA 7 & 9 ATEX IECEx	ATEX / IECEx						IP65
									air (★)				Ex db	Ex eb mb	Ex mb	Ex ia			
(❖)	(mm)	(m ³ /h)	(l/min)	~	=	~/=	EF ⁽²⁾	EV ⁽²⁾	LPKF	NF	EM	PV	LI	WSLI	SC				
5/2 - Solenoid air pilot operated and return (bistable)																			
1/4	6	0,75	12,5	0/2	10	10	BP	-	-	-	●	●	-	-	-	●	❖551A422		
							BP	●	●	-	-	-	-	-	-	-	-	❖551H422	
							LP	-	-	●	●	○	○	-	-	-	●	❖551A322	
							LP	○	○	-	-	-	-	-	-	-	-	❖551G322	
							ULP	-	-	○	-	-	-	○	○	-	-	❖551A322	
							ULP	○	○	-	-	-	-	-	-	-	-	❖551H322	
1/2	13	3,15	52,5	0/2	10	10	BP	-	-	-	●	●	-	-	-	●	❖553A422		
							BP	●	●	-	-	-	-	-	-	-	❖553H422		
							LP	-	-	●	●	○	○	-	-	-	●	❖553A322	
							LP	○	○	-	-	-	-	-	-	-	-	❖553G322	
							ULP	-	-	○	-	-	-	○	○	-	-	❖553A322	
							ULP	○	○	-	-	-	-	-	-	-	-	❖553H322	
5/3 - W1 - pressure held, solenoid air pilot operated and return																			
1/4	6	0,66	11	0/2	10	10	BP	-	-	-	●	●	●	-	-	●	❖551A438		
							LP	-	-	●	●	○	-	-	-	●	❖551A338		
							ULP	-	-	○	-	-	-	○	○	-	-	❖551A338	
5/3 - W3 - pressure release, solenoid air pilot operated and return																			
1/4	6	0,66	11	0/2	10	10	BP	-	-	-	●	●	●	-	-	●	❖551A439		
							LP	-	-	●	●	●	○	-	-	●	❖551A339		
							ULP	-	-	○	-	-	-	○	-	-	❖551A339		

❖ Select 8 for NPT ANSI 1.20.3 or select G for ISO G (228/1) ● Available feature ○ Available feature in DC only. - Not available

⁽¹⁾ Zero minimum is only achieved if external pressure is applied.

⁽²⁾ UL CSA



Prefix table

prefix							description	power level			
1	2	3	4	5	6	7		ULP	LP	MP	BP
E	F						Explosionproof - NEMA 7, 9 - Zinc plated steel conduit (18" continuous leads)	○	○	-	●
E	F	H	T				EF (18" continuous leads) + high temperature	○	○	-	●
E	F	H	T	L			EF + high temperature + 72" continuous leads	○	○	-	●
E	F	L					EF + 72" continuous leads	○	○	-	●
J	B	E	F				EF + Junction box (conduit in 1/2" NPT)	○	○	-	●
J	B	E	F	M	F		EF + Junction box (conduit in 1/2" NPT) + surge suppression coils	○	○	-	●
J	C	E	F				EF + Junction box (conduit in 3/4" NPT)	○	○	-	●
J	C	E	F	H	T		EF + Junction box (conduit in 3/4" NPT) + high temperature	○	○	-	●
E	V						Explosionproof - NEMA 7, 9 - 316 SS conduit (18" continuous leads)	○	○	-	●
E	V	H	T				EV (18" continuous leads) + high temperature	○	○	-	●
E	V	H	T	L			EV + high temperature + 72" continuous leads	○	○	-	●
E	V	L					EV + 72" continuous leads	○	○	-	●
E	V	M	F				EV + surge suppression coils	○	○	-	●
E	V	M	F	L			EV + surge suppression coils + 72" continuous leads	○	○	-	●
E	M						Waterproof IP66/67 - Metal enclosure (EN/IEC 60079-7,-18 and -31)*	-	●	-	●
		E	T				Threaded conduit/hole (M20 x 1,5)	-	●	-	●
L	P	K	F				Flameproof - Aluminium (EN/IEC 60079-1, 60079-31)*	○	●	-	-
N	F						Flameproof - Aluminium (EN/IEC 60079-1, 60079-31)*	-	●	-	●
P	V						Encapsulated epoxy moulded (EN/IEC 60079-18)*	-	○	-	●
S	C						Solenoid with spade plug connector (EN/IEC 60730)	-	●	-	●
W	P						Waterproof IP67 - Metal enclosure	-	●	-	●
L	I						I.S. with Aluminium IP66/IP67 enclosure (EN/IEC 60079-11+31)*	○	-	-	-
W	S						Waterproof IP67 - 316 SS enclosure	-	●	-	-
W	S	L	P	K	F		Flameproof 316L SS (EN/IEC 60079-1, 60079-31)*	○	●	-	-
W	S	E	M				Waterproof IP66/67 - 316 SS enclosure (EN/IEC 60079-0+7+18+31)*	-	●	-	●
W	S			L	I		I.S. with 316L SS IP66/IP67 enclosure (EN/IEC 60079-11+31)*	○	-	-	-
W	S	N	F				Flameproof 316L SS (EN/IEC 60079-1, 60079-31)*	-	●	-	●
		T					Threaded conduit (1/2" NPT)	-	●	-	●
				H	T		Class H - High temperature, +80°C ambient temp.	-	-	-	●
						X	Other special constructions	-	●	-	●

Product selection guide

STEP 1
Select basic catalogue number, including pipe thread identification letter. Refer to the specifications table on page: 1 or 2

Example: G551A421

STEP 2
Select prefix (combination). Refer to the specifications table and the prefix table, respect the indicated power level.

Example: EM

STEP 3
Select suffix (combination) if required. Refer to the suffix table, respect the indicated power level. **Example: MO**

STEP 4
Select voltage. Refer to standard voltages on page: 4

Example: 230V / 50Hz

STEP 5
Final catalogue / ordering number.

Example:
EM G551A421MO 230 V / 50 Hz

Suffix table

suffix							description	power level			
1	2	3	4	5	6	7		ULP	LP	MP	BP
			M	O			Push type manual operator	○	○/●	-	●
	S	L					Certified IEC 61508 Functional Safety data ⁽¹⁾	○	○/●	-	●

Options & Accessories

series	pipe size	exhaust protector (stainless steel)		
		G	NPT	(M)
551-553	1/8	34600418 ⁽²⁾	34600482 ⁽²⁾	-
551	1/4	34600419 ⁽²⁾	34600483 ⁽²⁾	-
553	1/2	34600479 ⁽²⁾	34600479 ⁽²⁾	-
551	M5	-	-	34600484 ⁽²⁾

● Available feature ○ Available feature in DC only - Not available

* ATEX/IECEx valves using these solenoids are approved according to EN ISO 80079-36 (2016) and EN ISO 80079-37 (2016) [non electrical]

⁽¹⁾ Not to use with MO suffix

⁽²⁾ Provided with "SL" suffix

Ordering examples valves:

SC	G	553	A	421	230V / 50 Hz
SC	G	551	A	421	SL 230V / 50 Hz
SC	G	551	A	422	MO 230V / 50 Hz
SCHT	8	551	A	422	MO 230V / 50 Hz
LPKF	G	551	A	321	MO 24V / DC
WSLI	G	551	A	321	24V / DC
EM	8	551	A	421	MO 230V / 50 Hz
EF	G	551	H	421	MO 240V / 60 Hz

prefix ———
pipe thread ———
basic number ——— voltage ———
suffix ———

Explanation of temperature ranges of solenoid valves

- Valve temperature range The valve temperature range (TS) is determined by the selected seal material, the temperature range for proper operation of the valve and sometimes by the fluid (e.g. steam)
- Operator ambient temperature range The operator ambient temperature range is determined by the selected power level and the safety code
- Total temperature range The temperature range of the complete solenoid valve is determined by the limitations of both temperature ranges above

Electrical characteristics

- Coil insulation class F
- Electrical safety IEC 335
- Standard voltages DC (=) 24V - 48V
AC (~) 24V - 48V - 115V - 230V⁽¹⁾/50Hz; other voltages and 60Hz are available on request

prefix option	power ratings				operator ambient temperature range (TS) (C°) ⁽²⁾	safety code	electrical enclosure protection (EN 60529)	replacement coil / kit		type ⁽³⁾
	inrush ~	holding ~	hot/cold =					~	=	
	(VA)	(VA) (W)	(W)	(W)				230 V/50 Hz	24V/DC	
Basic power (BP)										
SC	55	23	10,5	9/11,2	-40 to +75	EN 60730	IP65, moulded	400425-117	400425-142	01
WP/WS	55	23	10,5	9/11,2	-40 to +75	EN 60730	IP67, steel /SS	400405-117	400405-142	03
NF/WSNF	55	23	10,5	-	-60 to +25/40/60	II2G Ex db IIC Gb T6/T5/T4, II2D Ex tb IIIC Db	IP66/67, alu./SS	400405-117	-	02
NF/WSNF	-	-	-	9/11,2	-60 to +40/60/75	II2G Ex db IIC Gb T6/T5/T4, II2D Ex tb IIIC Db	IP66/67, alu./SS	-	400405-142	02
EM/WSEM	55	23	10,5	9/11,2	-40 to +40	II2G Ex eb mb IIC Gb T3, II2D Ex tb IIIC Db	IP66/67, steel /SS	400909-117	400913-142	03
PV	55	23	10,5	9/11,2	-40 to +65	II2G Ex mb IIC Gb T3(-)/T4(=), II2D Ex mb IIIC Db	IP67, moulded	-(4)	-(4)	04
EF	55	23	10,5	9/11,2	-40 to +52/40	NEMA type 7 and 9	NEMA 4X	-	-	05
EFHT	55	23	10,5	9/11,2	-40 to +52/40	NEMA type 7 and 9	NEMA 4X	-	-	05
JBEF	55	23	10,5	9/11,2	-40 to +52/40	NEMA type 7 and 9	NEMA 4X	-	-	11
JBEFHT	55	23	10,5	9/11,2	-40 to +52/40	NEMA type 7 and 9	NEMA 4X	-	-	11
EV	55	23	11,6	9/11,6	-40 to +52/40	NEMA type 7 and 9, ATEX II 2G Ex db mb IICT* Gb II 2D Ex mb tb IIIC T* Db IECEX Ex db mb IIC T* Gb Ex mb tb IIIC T* Db	NEMA 4X	-	-	05
EVHT	55	23	11,6	9/11,6	-40 to +52/40	NEMA type 7 and 9, ATEX II 2G Ex db mb IICT* Gb II 2D Ex mb tb IIIC T* Db IECEX Ex db mb IIC T* Gb Ex mb tb IIIC T* Db	NEMA 4X	-	-	05
EVMF	55	23	11,6	9/11,6	-40 to +52/40	NEMA type 7 and 9, ATEX II 2G Ex db mb IICT* Gb II 2D Ex mb tb IIIC T* Db IECEX Ex db mb IIC T* Gb Ex mb tb IIIC T* Db	NEMA 4X	-	-	05
Low Power (LP)										
SC	1,5	1,5	1,5	1,7/1,7	-40 to +60	EN 60730	IP65, moulded	400925-097	400925-042	06
WP/WS	1,5	1,5	1,5	1,7/1,7	-40 to +60	EN 60730	IP67, steel /SS	400926-097	400926-042	08
LPKF/WSLPKF	2,4	2,4	2,4	-	-40 to +40/65/80	II2G Ex db IIB+H2 Gb T6/T5/T4, II2D Ex tb IIIC Db	IP66/67, alu./SS	-(4)	-(4)	12
LPKF/WSLPKF	-	-	-	2,1 ⁽⁵⁾	-40 to +40/80	II2G Ex db IIB+H2 Gb T6/T4, II2D Ex tb IIIC Db	IP66/67, alu./SS	-(4)	-(4)	12
NF/WSNF	1,85	1,85	1,85	1,5/1,8	-60 to +75/80	II2G Ex db IIC Gb T6/T5, II2D Ex tb IIIC Db	IP66/67, alu./SS	-(4)(1)	-(4)	07
EM/WSEM	1,5	1,5	1,5	1,7/1,7	-40 to +40/55	II2G Ex eb mb IIC Gb T6/T5, II2D Ex tb IIIC Db	IP66/67, steel /SS	-(4)	-(4)	08
PV	-	-	-	1,7/1,7	-40 to +65	II2G Ex mb IIC Gb T6, II2D Ex mb IIIC Db	IP67, moulded	-	-(4)	09
EF	-	-	-	1,8/1,8	-40 to +60	NEMA type 7 and 9	NEMA 4X	-	-	10
EFHT	-	-	-	1,8/1,8	-40 to +60	NEMA type 7 and 9	NEMA 4X	-	-	10
JBEF	-	-	-	1,8/1,8	-40 to +60	NEMA type 7 and 9	NEMA 4X	-	-	11
JBEFHT	-	-	-	1,8/1,8	-40 to +60	NEMA type 7 and 9	NEMA 4X	-	-	11
EV	-	-	-	1,7/1,7	-40 to +60	NEMA type 7 and 9, ATEX II 2G Ex db mb IICT* Gb II 2D Ex mb tb IIIC T* Db IECEX Ex db mb IIC T* Gb Ex mb tb IIIC T* Db	NEMA 4X	-	-	10
EVHT	-	-	-	1,7/1,7	-40 to +60	NEMA type 7 and 9, ATEX II 2G Ex db mb IICT* Gb II 2D Ex mb tb IIIC T* Db IECEX Ex db mb IIC T* Gb Ex mb tb IIIC T* Db	NEMA 4X	-	-	10
EVMF	-	-	-	1,7/1,7	-40 to +60	NEMA type 7 and 9, ATEX II 2G Ex db mb IICT* Gb II 2D Ex mb tb IIIC T* Db IECEX Ex db mb IIC T* Gb Ex mb tb IIIC T* Db	NEMA 4X	-	-	10

prefix option	power ratings			operator ambient temperature range (TS) (C°) ⁽²⁾	safety code	electrical enclosure protection (EN 60529)	replacement coil / kit		type ⁽³⁾
	inrush	holding	hot/cold				~	=	
	(VA)	(VA) (W)	(W)				230 V/50 Hz	24V/DC	
Ultra Low Power (ULP)									
LPKF/WSLPKF	-	-	0,5/0,5 ⁽⁵⁾	-40 to +60	II2G Ex db IIB+H2 Gb T6, II2D Ex tb IIIC Db	IP66/67, alu./SS	-	- ⁽⁴⁾	12
EF	-	-	0,55/0,7	-40 to +52/40	NEMA type 7 and 9	NEMA 4X	-	-	10
EFHT	-	-	0,55/0,7	-40 to +52/40	NEMA type 7 and 9	NEMA 4X	-	-	10
JBEF	-	-	0,55/0,7	-40 to +52/40	NEMA type 7 and 9	NEMA 4X	-	-	10
JBEFHT	-	-	0,55/0,7	-40 to +52/40	NEMA type 7 and 9	NEMA 4X	-	-	11
EV	-	-	0,55/0,7	-40 to +52/40	NEMA type 7 and 9, ATEX II2G Ex db mb IICT* Gb II2D Ex mb tb IICT* Db IECEX Ex db mb IICT* Gb Ex mb tb IICT* Db	NEMA 4X	-	-	10
EVHT	-	-	0,55/0,7	-40 to +52/40	NEMA type 7 and 9, ATEX II2G Ex db mb IICT* Gb II2D Ex mb tb IICT* Db IECEX Ex db mb IICT* Gb Ex mb tb IICT* Db	NEMA 4X	-	-	10
EVMF	-	-	0,55/0,7	-40 to +52/40	NEMA type 7 and 9, ATEX II2G Ex db mb IICT* Gb II2D Ex mb tb IICT* Db IECEX Ex db mb IICT* Gb Ex mb tb IICT* Db	NEMA 4X	-	-	10
LI ⁽⁶⁾⁽⁷⁾	-	-	0,5/0,5	-40 to +60	II1G Ex ia IIC T6 Ga, II2D Ex tb IIIC Db ⁽⁷⁾	IP66/67, alu.	-	- ⁽⁴⁾	13
WSLI ⁽⁶⁾⁽⁷⁾	-	-	0,5/0,5	-40 to +60	II1G Ex ia IIC T6 Ga, II2D Ex tb IIIC Db ⁽⁷⁾	IP66/67, SS	-	- ⁽⁴⁾	13

prefix option	safety parameters				
	U _i = (DC)	I _i	P _i	L _i	C _i
	(V)	(mA)	(W)	(H)	(μF)
Ultra Low Power (ULP)					
LI/WSLI	32	500	1,5	0	0

⁽¹⁾ (WS)NF: Low Power, 230 V AC does not exist. Maximum voltage in AC is 115 V

⁽²⁾ Temperature range can be limited by sealings

⁽³⁾ Refer to the dimensional drawings on pages: 6 to 9

⁽⁴⁾ Multiple coil kits are available under ATEX/IECEX, contact us

⁽⁵⁾ LPKF/WSLPKF: 24 V DC (0,5 W)

⁽⁶⁾ LI/WSLI: Check the electrical characteristics in the corresponding catalogue pages

⁽⁷⁾ LI/WSLI: Ultra Low Power, 24 V DC only (LI: **For use in zone 0 locations, see the installation conditions given in the I&M instructions**)

- Not available

Electrical connections

prefix	connection
SC	Spade plug connector with cable gland EN175301-803A (ISO 4400) for cables with an outer diameter from 6 to 10 mm
WP, WS, EM, WSEM	M20 plastics cable gland for cables with an outer diameter from 7 to 12 mm.
NF, WSNF, LPKF, WSLPKF	1/2" NPT threaded cable entry. Enclosures are supplied without cable gland
PV	Moulded-in cable, standard length 2 m
LI, WSLI	1/2" NPT threaded cable entry. Enclosures are supplied without cable gland
EF, EV	Conduit 1/2 NPT
JBEF	EF + Junction box

Additional options

- Valves configured for external pilot air supply, TPL 20547
- Other pipe threads are available on request
- Ex mb (prefix "PV") solenoid can be supplied with various cable lengths

Installation

- Multi language installation/maintenance instructions are included with each valve
- The solenoid valves can be mounted in any position without affecting operation
- Do not connect the pressure supply to the exhaust port 3. The "environmentally-protected" construction is not adapted for a "distributing" function or use in NO function. Contact us for functions available in specific versions
- IEC 61508 Functional Safety (suffix SL). Check temperature range of valve body and solenoid for suitability. For probability of failure, contact us
- It is necessary to connect pipes or fittings to the exhaust ports to protect the internal parts of the spool valve and its pneumatic operator if used outside or in harsh environments (dusts, liquids etc.)
- Threaded pipe connection identifier is 8 = NPT (ANSI 1.20.3); G = G (ISO 228/1)
- Ex db Prefix "NF/WSNF" enclosure is provided with a 1/2" NPT threaded entry hole, M20 x 1,5 (prefix "ET") is optional. These are supplied without cable gland

5/2 - 5/3
 SERIES
 551 - 553

Dimensions (mm), Weight (kg) 

551 Series

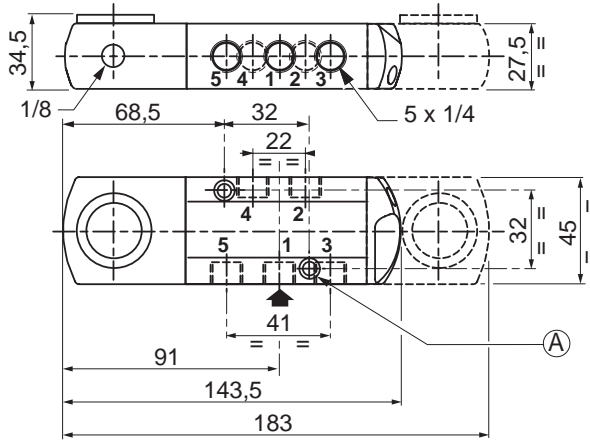

2 mounting holes

(A) 5,3 mm dia.; Spotfacing: 9 mm dia., depth 5 mm

(B) 6,5 mm dia.; Spotfacing: 11 mm dia., depth 6 mm

553 Series

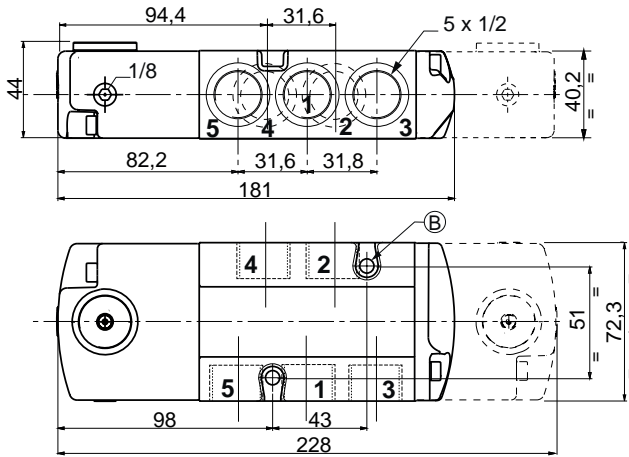

TYPE 01:
 Epoxy moulded
 SC: IEC 335 / ISO 4400

551A421 / 551A422 / 551A438 / 551A439 / 553A421 / 553A422



TYPE 02:
 Aluminium, epoxy coated / AISI 316L SS
 NF / WSNF: EN/IEC 60079-1, 60079-31

551A421 / 551A422 / 551A438 / 551A439 / 553A421 / 553A422

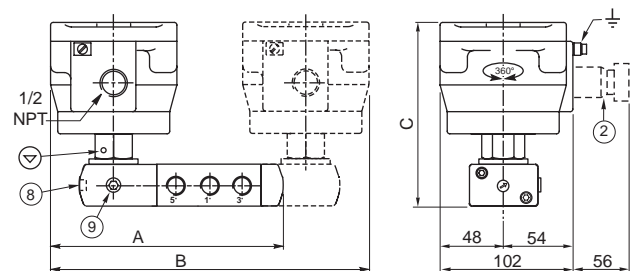
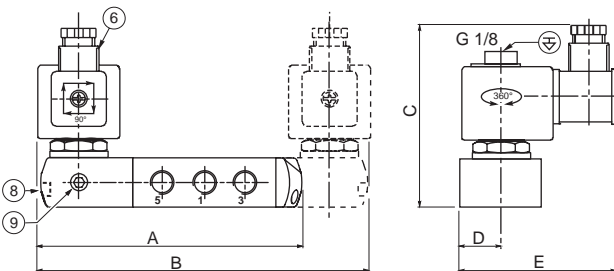

Dimensions (mm), Weight (kg)



TYPE 03:
 Metal, epoxy coated / AISI 316L SS
 WP / WS: IEC 335
 EM / WSEM: EN/IEC 60079-7+18+31

551A421 / 551A422 / 551A438 / 551A439 / 553A421 / 553A422

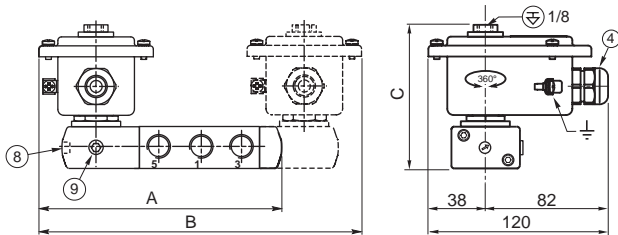

TYPE 04:
 Epoxy encapsulated
 PV: EN/IEC 60079-18

551A421 / 551A422 / 551A438 / 551A439 / 553A421 / 553A422

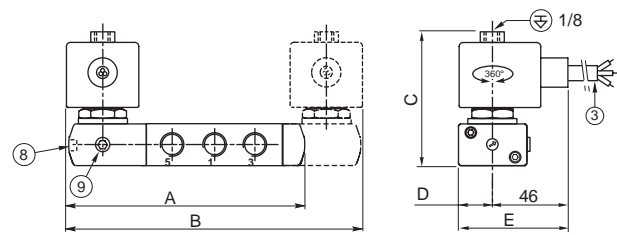

TYPE 05:
 Epoxy encapsulated
 EF and EV: NEMA type 7, 9 / ICS-6 ANSI

551H421 / 551H422 / 553H421 / 553H422

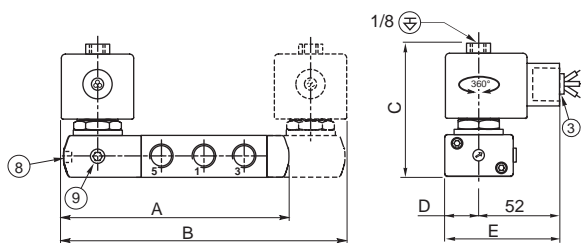

TYPE 06:
 Epoxy moulded
 SC: IEC 335 / ISO 4400

551A321 / 551A322 / 551A338 / 551A339 / 553A321 / 553A322

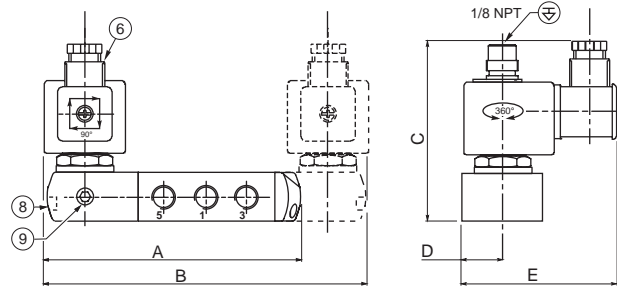

TYPE 07:
 Aluminium, epoxy coated / AISI 316L SS
 NF / WSNF: EN/IEC 60079-1, 60079-31

551A321 / 551A322 / 551A338 / 551A339 / 553A321 / 553A322

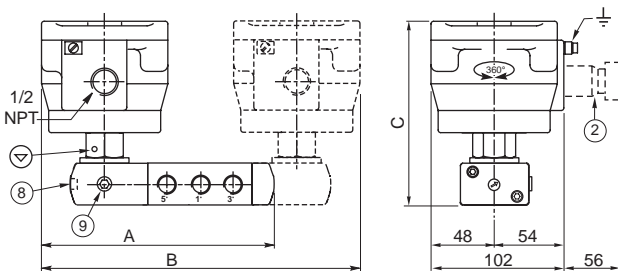

TYPE 08:
 Metal, epoxy coated / AISI 316L SS
 WP / WS: IEC 335
 EM / WSEM: EN/IEC 60079-7+18+31

551A321 / 551A322 / 551A338 / 551A339 / 553A321 / 553A322

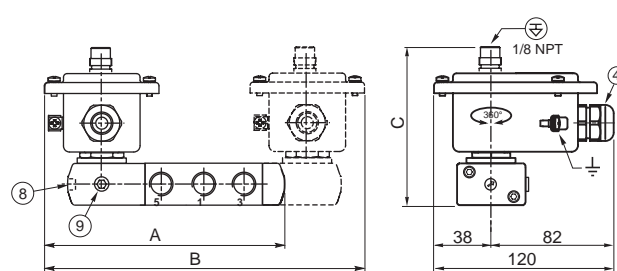

**5/2 - 5/3
SERIES
551 - 553**

Dimensions (mm), Weight (kg)



TYPE 09:
Epoxy encapsulated
PV: EN/IEC 60079-18

551A321 / 551A322 / 551A338 / 551A339 / 553A321 / 553A322

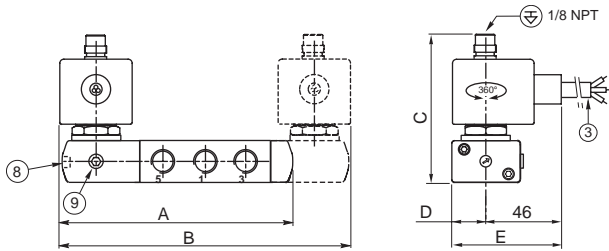

TYPE 10:
Epoxy encapsulated
EF and EV: NEMA type 7, 9 / ICS-6 ANSI

551G321/551H321/551G322/551H322/553G321/553H321/553G322/553H322

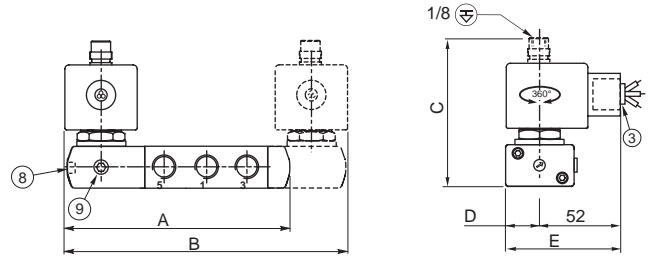

TYPE 11:
Epoxy encapsulated
JBEF: NEMA type 7, 9

551G321/551H321/551G322/551H322/553G321/553H321/553G322/553H322

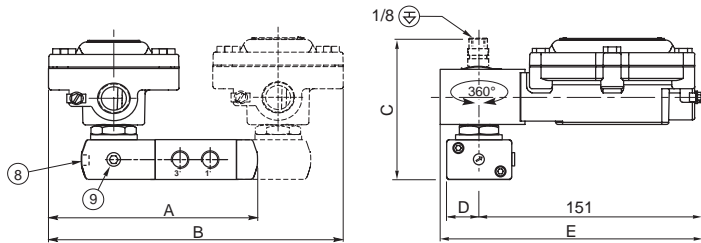

TYPE 12:
Aluminium, cataphoresis black painting / AISI 316L SS
LPKF/WSLPKF: EN/IEC 60079-1, 60079-31

551A321 / 551A322 / 551A338 / 551A339 / 553A321 / 553A322

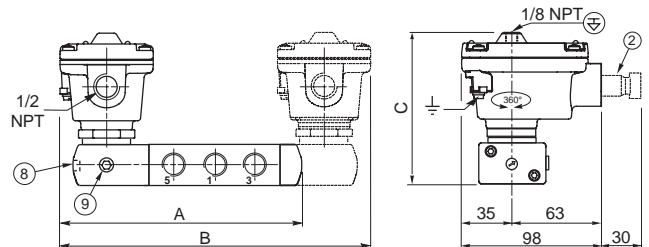

TYPE 13:
Aluminium, cataphoresis black painting / AISI 316L SS
LI / WSLI: EN/IEC 60079-11, 60079-31

551A321 / 551A322 / 551A338 / 551A339 / 553A321 / 553A322

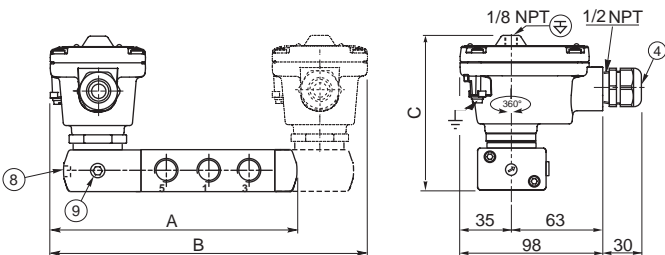

Dimensions (mm), Weight (kg)

type	prefix/option	power level	551					553					weight ⁽¹⁾			
			A	B	C	D	E	A	B	C	D	E	monostable		bistable	
													551	553	551	553
01	SC	BP	144	184	103	22,5	87	181	229	109	36,15	101	1,27	3,06	2,03	4,38
02	NF	BP	170	236	142	-	-	208	281	148	-	-	2,42	4,21	4,13	6,48
02	WSNF	BP	170	236	142	-	-	208	281	148	-	-	3,72	5,51	6,73	9,08
04	WP / WS / EM / WSEM	BP	160	216	103	-	-	198	261	109	-	-	1,70	3,49	2,69	5,04
05	PV	BP	144	184	88	22,5	69	181	229	94	36,15	82,5	1,37	3,16	2,03	4,38
06	EF / EV	BP	145	185	86	22,5	75	183	230	92	36,15	88,5	1,37	3,16	2,03	4,38
07	SC	LP	145	185	102	22,5	88	183	230	108	36,15	102	1,27	3,06	2,03	4,38
08	NF	LP	170	236	142	-	-	208	281	148	-	-	2,42	4,21	4,13	6,48
08	WSNF	LP	170	236	142	-	-	208	281	148	-	-	3,72	5,51	6,73	9,08
09	WP / WS / EM / WSEM	LP	160	216	102	-	-	198	261	108	-	-	1,70	3,49	2,69	5,04
10	PV	LP	144	184	101	22,5	69	181	229	110	36,15	82,5	1,37	3,16	2,03	4,38
11	EF / EV	BP / LP / ULP	145	185	101	22,5	75	183	230	110	36,15	88,5	1,37	3,16	2,03	4,38
12	JBEF	LP / ULP	165,5	225	100,5	22,5	176	200	267	110	36,15	187,16	1,90	3,56	3,34	5,15
13	LPKF	LP / ULP	153	204	113	-	-	193	252	118,7	-	-	1,39	4,48	2,31	4,68
13	WSLPKF	ULP	153	204	113	-	-	193	252	118,7	-	-	2,00	3,15	3,51	5,75
14	LI	ULP	153	204	113	-	-	193	252	118,7	-	-	1,40	4,49	2,32	4,69
14	WSLI	LP	153	204	113	-	-	193	252	118,7	-	-	2,01	3,16	3,52	5,76

⁽¹⁾ Incl. coil(s) and connector(s).

- ② Ex d certified cable gland (on request)
- ③ Three-core cable, length 2 m
- ④ Cable gland for unarmoured cable with 7 to 12 mm dia. sheath
- ⑥ Connector rotatable by 90° increments (cable Ø 6 - 10 mm)
- ⑧ Manual operator location, suffix MO
- ⑨ External pilot air supply, 1/8 pipe size
- ⊕ Connectable pilot exhaust port
- ⊖ Non-connectable pilot exhaust port

Accessories

